

Article number: 2310415121

Description: E+G Vibration-damping levelling element
LW.A-120-M16x1.5x130

Measures

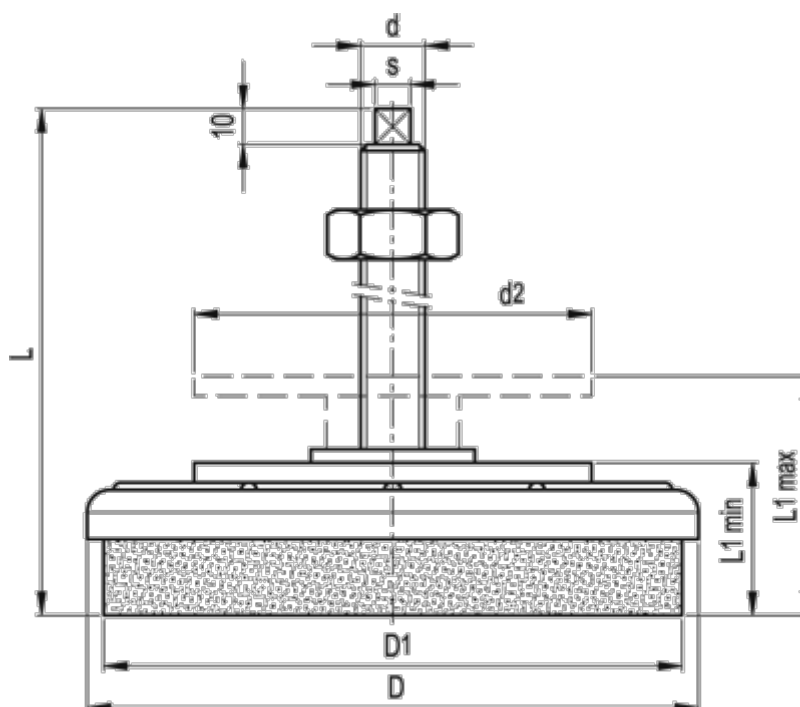

d	= M16x1.5	s	= 9x9
D	= 120	Static load (N)	= 10000
d1	= 109	Stiffness (N/mm)	= 4000
d2	= 80	Weight (g)	= 1200
L	= 150		
L1 max.	= 58		
L1 min.	= 45		
Max deflection	= 2.5		